



# General Instruments

Artery Forceps	10
Clamps	13
Spring Forceps	14
Tissue Forceps	16
Sponge Holding and Sterilising Forceps	18
Other Forceps	19
Scissors	20
Needle Holders	25
Combined Scissor and Needle Holders	29
Bag and Towel Clips	30
Retractors	31
Dissectors and Probes	39
Miscellaneous	40
Hollow Ware	41
Silicone Matting	42
Wire Sterilising Baskets	42
Optical Fibre Cables	44

SURGEON'S FIRST CHOICE

# Artery Forceps

## Adson Artery Forceps

Box joint, 180mm long

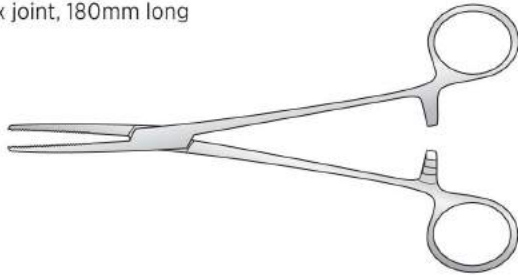

### Serrated jaws

Description
Straight
Curved



### 1-2 teeth

Description
Straight
Curved

## Cushing Artery Forceps

Box joint, fine, half serrated jaws, 140mm long

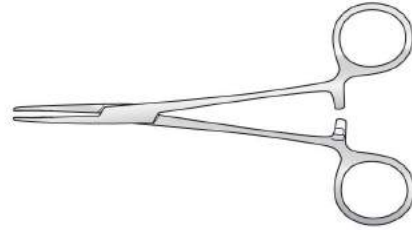

Description
Straight
Curved

## Cairns Artery Forceps

Box joint, half serrated jaws  
145mm long

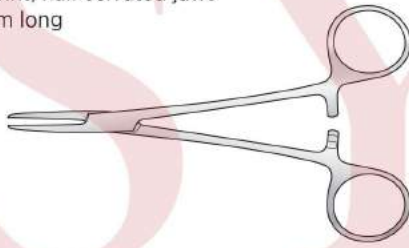

### Serrated jaws

Description
Straight

### 1-2 teeth

Description
Curved
Curved to side

## Dunhill Artery Forceps

Box joint, fine serrations

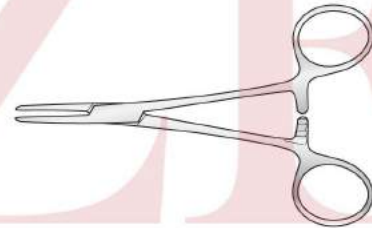

### Straight

Description
135mm long
190mm long

### Curved

Description
135mm long
180mm long

## Crile Artery Forceps

Box joint, serrated jaws

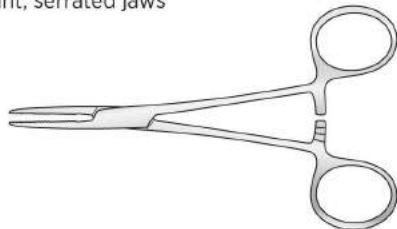

### Straight

Description
140mm long
160mm long

### Curved

Description
140mm long
160mm long

## Lawson Tait Artery Forcep

Box joint, straight jaw



Description
140mm long

# Artery Forceps

## Halstead Mosquito Forceps

Standard pattern, haemostatic, box joint

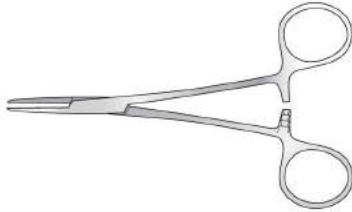

## Kelly Artery Forceps

Box joint, half serrated jaws



### Straight

Description
140mm long
160mm long

### Curved

Description
140mm long
160mm long



### Serrated jaw

Description
Straight 125mm long
Curved 125mm long
Fully curved 125mm long

### 1-2 teeth

Description
Straight 125mm long
Straight 190mm long
Curved 125mm long
Curved 190mm long

### Micro, 100mm long

Description
Straight, serrated
Curved, serrated
Straight, 1-2 teeth
Curved, 1-2 teeth

## Fraser Kelly Artery Forceps Curved

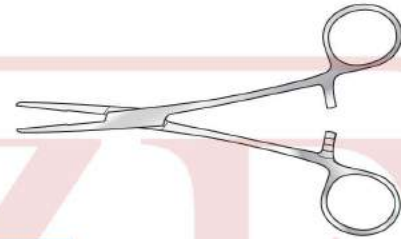

### Straight

Description
180mm

## Heiss Artery Forceps

Box joint, 205mm long

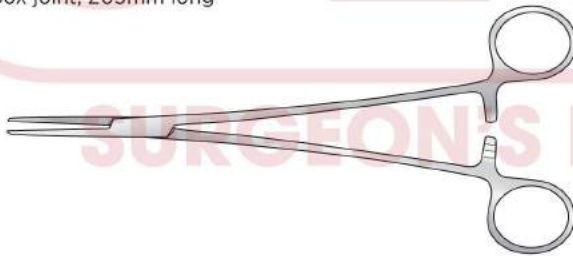

## Kocher Artery Forceps

Box joint, 1-2 teeth

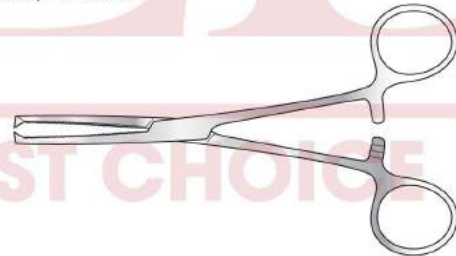

### Serrated jaws

Description
Straight
Curved

### 1-2 teeth

Description
Straight
Curved



### Straight

Description
130mm long
150mm long
180mm long
200mm long
230mm long

### Curved

Description
150mm long
180mm long
200mm long
230mm long

# Artery Forceps

## Moynihan Artery Forceps

Box joint, half-serrated jaws

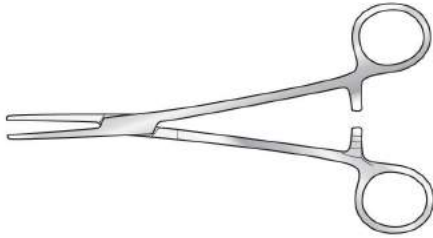

### Straight

Description
145mm long
180mm long

### Curved

Description
145mm long
180mm long

## Rochester-Pean Artery Forceps

Box joint

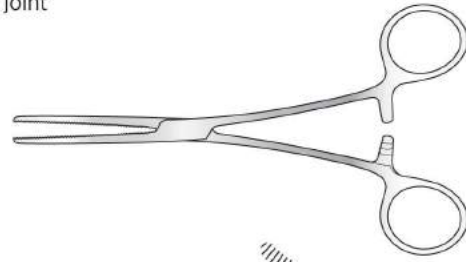

### Straight

Description
165mm long
190mm long
205mm long
240mm long

### Curved

Description
165mm long
180mm long
205mm long
240mm long

## Roberts Artery Forceps

Screw joint, curved on flat, serrated

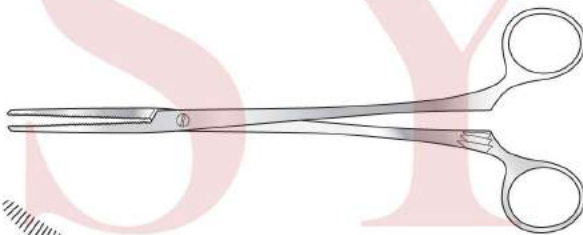

Description
230mm long

## Spencer Wells Artery Forceps

Box joint, serrated jaws

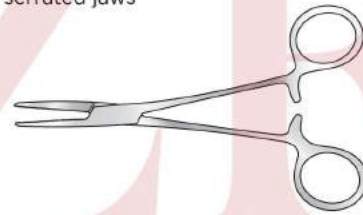

### Straight

Description
127mm long
152mm long
177mm long
203mm long

### Curved

Description
127mm long
152mm long
177mm long
203mm long

OTHER SIZES AVAILABLE

## Dandy Artery Forceps

Box joint, curved in plane

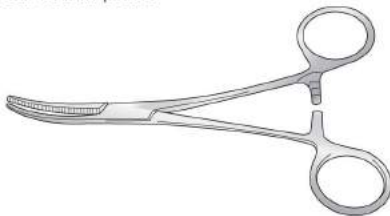

Description
140mm long



## Carmalt Angiotribe Forceps

Box joint, atraumatic, light pattern

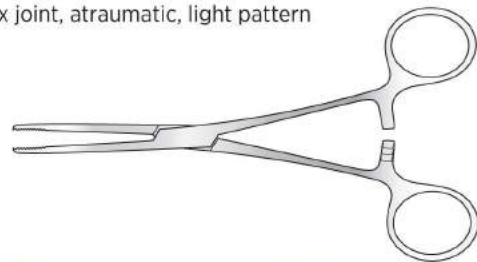

### Straight

Description
165mm long
200mm long
230mm long

### Curved

Description
165mm long

## Dieffenbach Bulldog Clamp



### Straight, serrated

Description
1.2mm fine jaw, 40mm long
1.2mm fine jaw, 45mm long
1.8mm jaw, 30mm long
1.8mm jaw, 35mm long
2.5mm jaw, 40mm long
2.5mm jaw, 45mm long
6mm heavy jaw, 60mm long
20mm jaw, 75mm long
30mm jaw, 85mm long
45mm jaw, 105mm long
65mm jaw, 120mm long

### Straight, plain

Description
1.2mm fine jaw, 40mm long
1.2mm fine jaw, 45mm long
1.8mm jaw, 30mm long
1.8mm jaw, 35mm long
2.5mm jaw, 40mm long
2.5mm jaw, 45mm long

### Curved, serrated

Description
1.2mm fine jaw, 40mm long
1.2mm fine jaw, 45mm long
1.8mm jaw, 30mm long
1.8mm jaw, 35mm long
2.5mm jaw, 40mm long
2.5mm jaw, 45mm long
6mm heavy jaw, 60mm long
20mm jaw, 75mm long
30mm jaw, 85mm long
45mm jaw, 105mm long
65mm jaw, 120mm long

### Curved, plain

Description
1.2mm fine jaw, 40mm long
1.2mm fine jaw, 45mm long
1.8mm jaw, 30mm long
1.8mm jaw, 35mm long
2.5mm jaw, 40mm long
2.5mm jaw, 45mm long

## Blalock Bulldog Clamp



### Serrated, with hole in handle

#### Straight

Description
11mm jaw, 38mm long
14mm jaw, 48mm long
17mm jaw, 60mm long
27mm jaw, 70mm long

#### Curved

Description
11mm jaw, 38mm long
14mm jaw, 48mm long
17mm jaw, 60mm long
27mm jaw, 70mm long

### Plain, with hole in handle

#### Straight

Description
11mm jaw, 38mm long
14mm jaw, 48mm long
17mm jaw, 60mm long
27mm jaw, 70mm long

#### Curved

Description
11mm jaw, 38mm long
14mm jaw, 48mm long
17mm jaw, 60mm long
27mm jaw, 70mm long

## An Overview On

# Forcep Jaw Types

You will see that forceps in our catalogue will have either a traditional serrated jaw or a different design which is known as atraumatic (or non-traumatic).

### Traditional Serrated Jaw



The traditional serrated jaw is generally more robust and used on forceps where the areas are not as delicate.

### Atraumatic Jaw



Atraumatic jaws will be mainly found in delicate surgery areas such as vascular and cardiothoracic. The design is such that the surface area gripped is reduced, ensuring less trauma without the loss of grip.

# Spring Forceps

## Adsons Dissecting Forceps

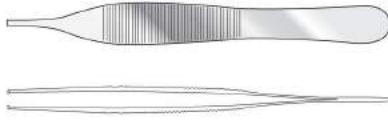

127mm long

Description
1-2 teeth
Lightweight, micro
Serrated
Serrated, lightweight, micro

## DeBakey Atraumatic Dissecting Forceps

Straight, atraumatic jaws

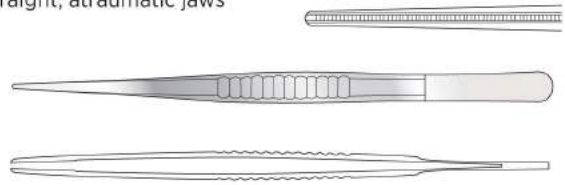

1.5mm

Description
150mm long
240mm long

2.5mm

Description
150mm long
240mm long

## Block End Dissecting Forceps

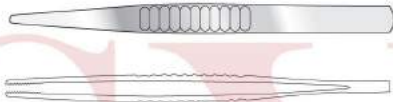

Serrated

Description
127mm long
152mm long
203mm long

2mm

Description
150mm long
180mm long

2.8mm

Description
150mm long
240mm long
180mm long

## Dissecting Forceps

Turnover end, serrated jaws

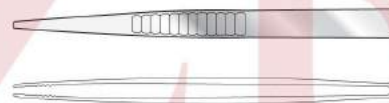

## Bonney Dissecting Forceps

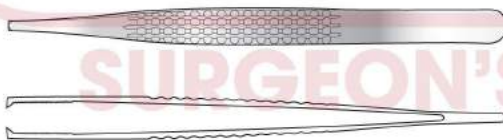

178mm long

Description
Serrated, 1-2 teeth
1-2 teeth

Description
127mm long
152mm long

Description
178mm long
203mm long

## Dunhill Dissecting Forceps

Light, fine serrated jaws



Description
145mm long

## Charnley-McIndoe Dissecting Forceps

150mm long



Description
2-3 teeth

## Fredrick Coole Dissecting Forceps

Extra fine serrated jaws

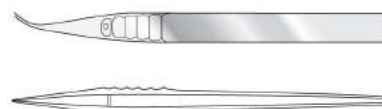

125mm long

Description
Straight
Curved

# Spring Forceps

## Gillies Dissecting Forceps

1-2 teeth

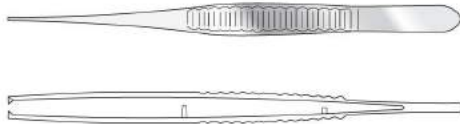

**Description**  
152mm long

## McIndoe Dissecting Forceps

152mm long

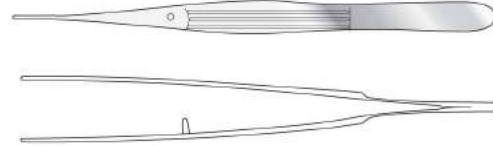

**Description**  
Serrated  
1-2 teeth

## Jackson Burrows Dissecting Forceps

140mm long

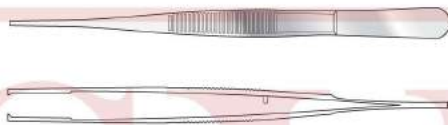

**Description**  
Tongue and groove, 1-2 teeth  
Tongue and groove only

## McIndoe Modified Dissecting Forceps

152mm long, 1mm tip, modified for fine powerful dissection with strong action tip

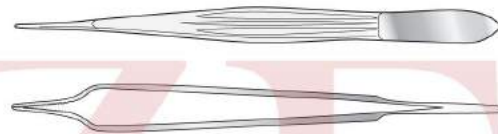

**Description**  
Serrated

## Jean Dissecting Forceps

Serrated jaws, 140mm long

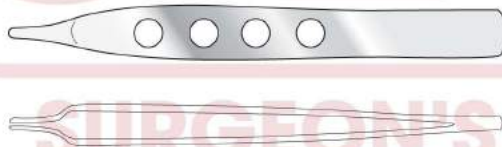

**Description**  
Fine  
1-2 teeth  
2-3 teeth, 178mm long

## Treves Dissecting Forceps

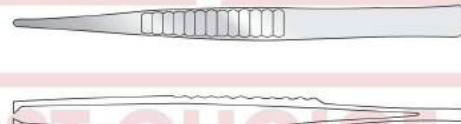

1-2 teeth

**Description**  
127mm long  
152mm long

2-3 teeth

**Description**  
127mm long  
152mm long

## Lanes Dissecting Forceps

1-2 teeth on serrated jaws, 140mm long



**Description**  
127mm long  
152mm long  
178mm long

**Description**  
2-3 teeth, 178mm long  
2-3 teeth, 203mm long

## Waugh Dissecting Forceps



Fine, serrated

**Description**  
152mm long  
178mm long  
203mm long

Fine, 1-2 teeth

**Description**  
152mm long  
178mm long  
203mm long

# Tissue Forceps

## Allis Tissue Forceps

Box joint

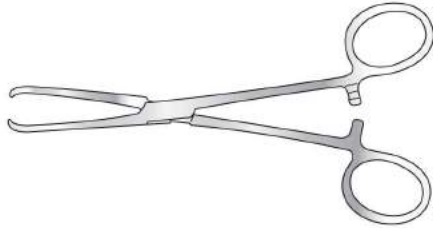

150mm long

Description
3-4 teeth
4-5 teeth

190mm long

Description
5-6 teeth

## Duval Tissue Forceps

Box joint

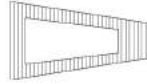
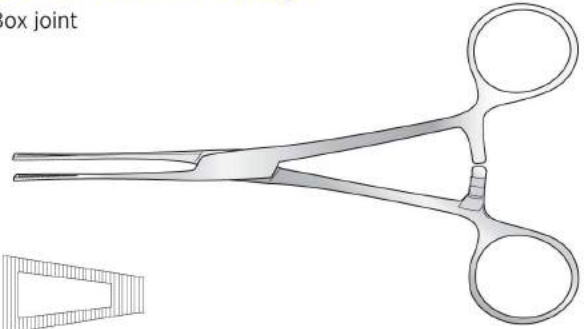

Description
13mm wide, 203mm long

## Littlewood Tissue Forceps

Box joint, 2-3 teeth

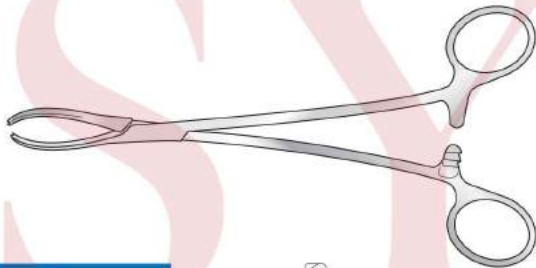

Description
190mm long

## Lane Tissue Forceps

Box joint, 1-2 teeth, fenestrated

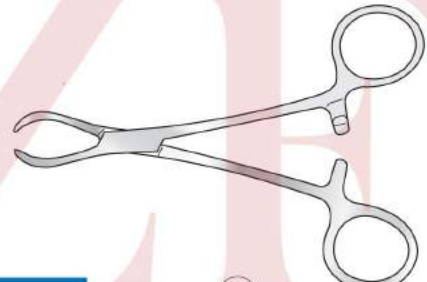

Description
127mm long
152mm long
197mm long

## Babcock Tissue Forceps

Box joint, serrated jaws

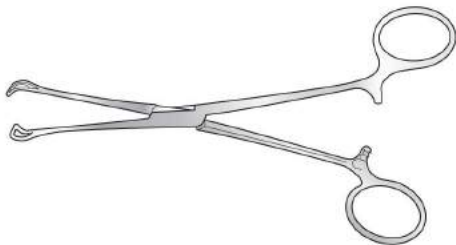

Description
160mm long
200mm long
230mm long

## Rutherford Morrison Tissue Forceps

Box joint

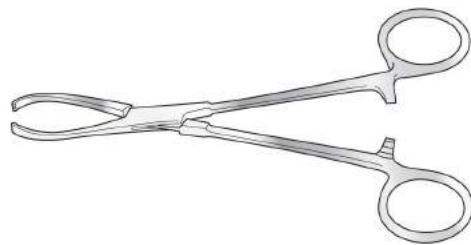

Description
4-5 teeth, 152mm long



SURGEON'S FIRST CHOICE



## Shaw Tissue Forceps

Box joint

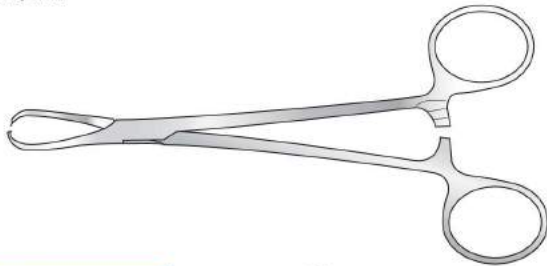

**Description**  
1-2 teeth, 178mm long



## Guys Gallabin Suture-Holding Forceps

Screw joint, angled flat blades

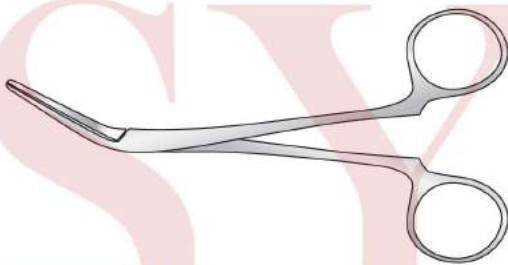

**Description**  
125mm long  
150mm long

## Russian Dissecting Forceps

With fenestrated end

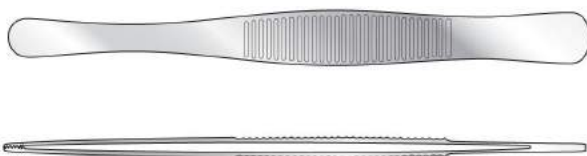

**Description**  
150mm long  
200mm long  
230mm long  
250mm long



## Special Offer

on SSD Essentials Pack

Top up your trays with these essentials...

CONTACT US FOR OUR OFFER PRICE

### Halstead Mosquito Forceps

Straight/Curved  
125mm (5")

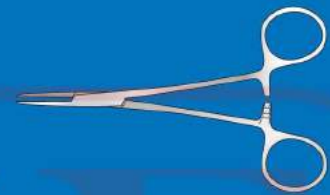

### Ramsey Sponge Holding Forceps

Straight, Serrated  
Jaws 241mm  
(9½")



### Scalpel Blade Handle

No. 3



### Spring Clip

Serrated Pattern,  
Stainless Steel for  
Fixing Slings to Leg  
Splints, also for  
Towel Clipping  
6.3cm (2½") Wide



### Spencer Wells Artery Forceps

Straight, Serrated  
Jaws



Email us to place your order

[info@syze.co](mailto:info@syze.co)

# Sponge Holding and Sterilising Forceps

## Rampley Sponge Holding Forceps

Box joint, straight, serrated jaws

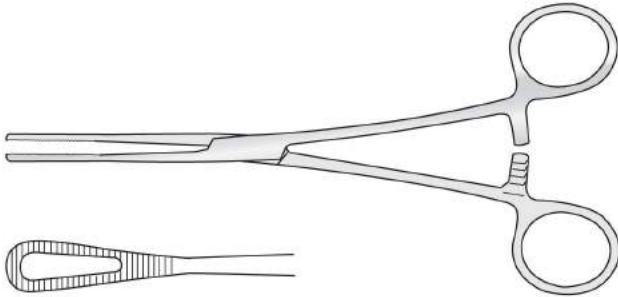

**Description**

178mm long  
241mm long

## Lister Sinus Forceps

Box joint, serrated tip

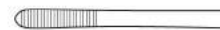
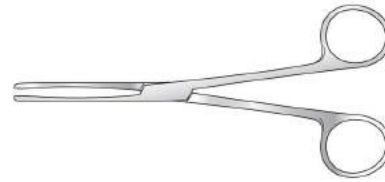

**Description**

127mm long  
152mm long  
178mm long

## Foerster Sponge Holding Forceps

Box joint, straight, serrated jaws

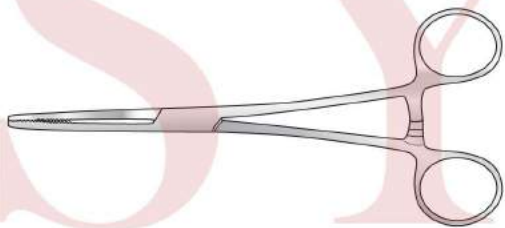

**Description**

178mm long



## Cheate Sterilizer Forceps

Screw joint

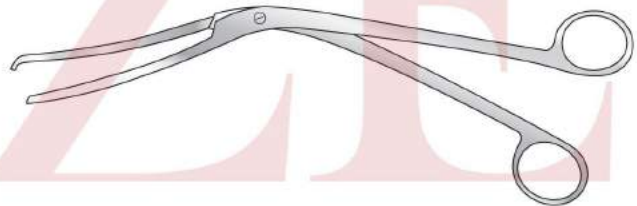

**Description**

267mm long

## Harrison Bowl Steriliser Forceps

Screw joint, angled, double jaw

**Description**

356mm long  
457mm long

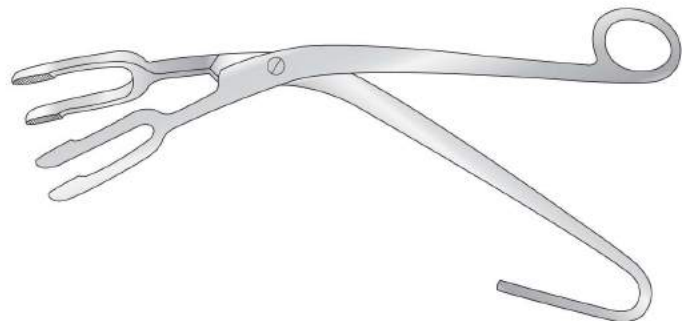

## Other Forceps

### Hunter Splinter Forceps

Serrated grooved pointed jaws



**Description**

115mm long

### Michel Forceps

Box joint, double-ended, for inserting and removing clips  
stainless steel

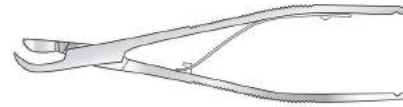

**Description**

130mm long

### Michel Skin Holding Forceps

With magazine for Michel clips

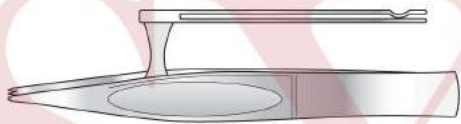

**Description**

1-2 teeth, 127mm long

### Michel Clip Extracting Forceps

Box joint

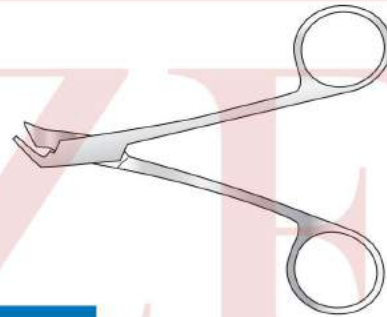

**Description**

125mm long

### Childe Approximating Forceps

With magazine for Michel clips



**Description**

180mm long

### Robins Anchoring Forceps

140mm long

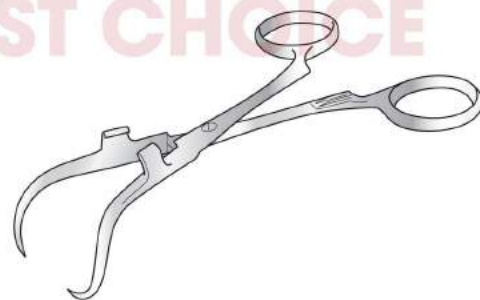

**Description**

5mm with holder for diathermy leads

13mm with holder for suction tubing

# Premium Quality Stainless Steel Scissors

## Dressing Scissors



### Blunt/Blunt

#### Straight

Description
130mm long
146mm long
165mm long

#### Curved

Description
130mm long
146mm long
165mm long
185mm long
147mm long

With one serrated blade

### Blunt/Sharp

#### Straight

Description
130mm long
146mm long
165mm long

### Sharp/Sharp

#### Straight

Description
130mm long
146mm long
165mm long

#### Curved

Description
130mm long

## Metzenbaum Scissors



### Straight

Description
180mm long
147mm long
200mm long
230mm long
250mm long
280mm long

### Curved

Description
185mm long
147mm long
200mm long
230mm long
250mm long
280mm long

## Dressing Scissors, Left-Handed

With one black bow, 145mm long

### Blunt/Blunt

Description
Straight
Curved



### Blunt/Sharp

Description
Straight
Curved

### Sharp/Sharp

Description
Straight
Curved

## Mayo Scissors

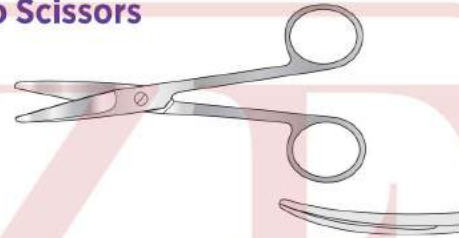

### Straight

Description
140mm long
160mm long
190mm long
230mm long

### Curved

Description
140mm long
160mm long
190mm long
230mm long

## Littler Dissecting Scissors

Fine pattern, with eye for suture

Description
115mm long

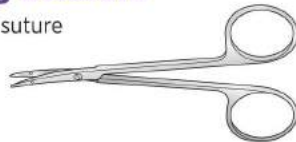

## Fergusson Scissors

Angled on flat

Description
180mm long



## Paynes Suture Scissors

Description
100mm long



## Kilner Dissecting Scissors

Fine pattern

Description
115mm long



## Ligature Stitch Scissors

Fine pattern

Description
115mm long

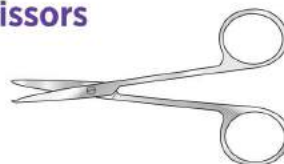

## Lister Bandage Scissors



Description
147mm long
178mm long

## Lister Bandage Scissors

Angled, with probe end



Description
147mm long
178mm long

## McIndoe Scissors

178mm long

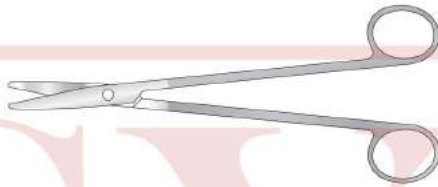

Description
Straight
Curved on flat
Supercut, curved

## Thomas Strabismus Scissors

114mm long



Description
Straight
Curved

## Heath Stitch Scissors

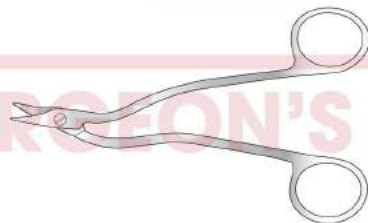

Description
152mm long

## “Careless” Scissors

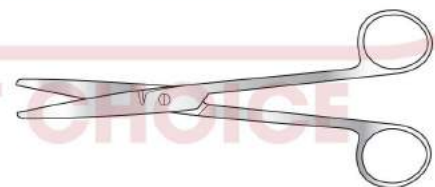

Description
165mm long

## Tubing Scissors



Description
130mm long

## Utility Scissors



Description
190mm long

# Tungsten Carbide Hard Insert Scissors

## Dressing Scissors

Tungsten carbide hard insert, blunt/blunt



### Straight

Description
130mm long
145mm long
165mm long
185mm long

### Curved

Description
130mm long
145mm long
165mm long

## Mayo Dressing Scissors

Tungsten carbide hard insert

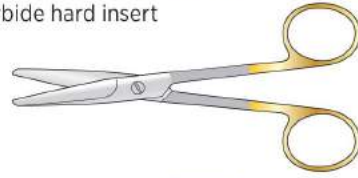

### Straight

Description
140mm long
160mm long
190mm long
230mm long

### Curved

Description
140mm long
160mm long
190mm long
230mm long

## Dressing Scissors

Tungsten carbide hard insert, blunt/sharp

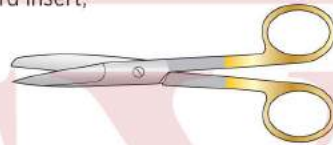

### Straight

Description
130mm long
145mm long
165mm long
185mm long

### Curved

Description
130mm long
145mm long
165mm long

## Mayo-Harrington Dressing Scissors

Tungsten carbide hard insert

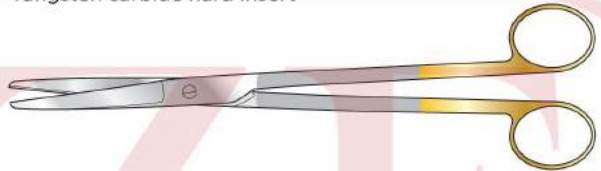

### 230mm long

Description
Straight
Curved

### 200mm long

Description
Straight
Curved

## Dressing Scissors

Tungsten carbide hard insert sharp/sharp



### Straight

Description
130mm long
145mm long
165mm long
185mm long

### Curved

Description
130mm long
145mm long
165mm long

## Metzenbaum Scissors

Tungsten carbide hard insert

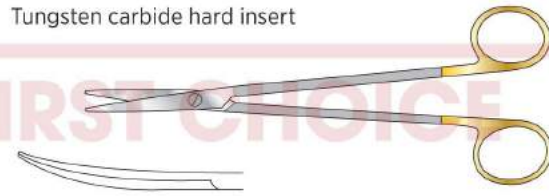

### 230mm long

Description
145mm long
185mm long
230mm long
250mm long
280mm long

### 200mm long

Description
145mm long
185mm long
200mm long
230mm long
250mm long
280mm long

## Baby Metzenbaum Scissors

Tungsten carbide, hard insert, 145mm long



Description
Straight
Curved

## Ligature Scissors

Tungsten carbide hard insert, curved

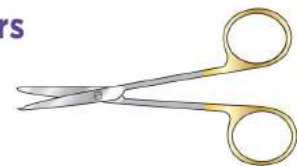

Description
145mm long
185mm long

# Tungsten Carbide Supercut Scissors

## Mayo Harrington Scissors

Supercut, tungsten carbide



230mm long

Description
Straight
Curved

200mm long

Description
Straight
Curved

## Dressing Scissors

Supercut, tungsten carbide



### Blunt/Blunt

#### Straight

Description
130mm long
145mm long
165mm long
185mm long

#### Curved

Description
130mm long
145mm long
165mm long
185mm long

## Mayo Scissors

Supercut, tungsten carbide

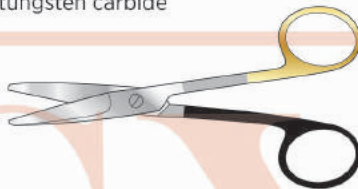

### Straight

Description
140mm long
160mm long
190mm long
230mm long

### Curved

Description
140mm long
160mm long
190mm long
230mm long

### Blunt/Sharp

#### Straight

Description
130mm long
145mm long
165mm long
185mm long

#### Curved

Description
130mm long
145mm long
165mm long
185mm long

### Sharp/Sharp

#### Straight

Description
130mm long
145mm long
165mm long
185mm long

#### Curved

Description
130mm long
145mm long
165mm long
185mm long

## Metzenbaum Dissecting Scissors

Supercut, tungsten carbide



### Straight

Description
185mm long
200mm long
230mm long
250mm long
280mm long

### Curved

Description
147mm
185mm
200mm
230mm
250mm
280mm

## Guide for Gold and Black Bows

It's important to know the difference for the intended use of each scissor:



**2 Gold Bows**  
Tungsten carbide insert or padding for a scissor



**2 Black Bows**  
Supercut edge



**1 Black and 1 Gold Bow**  
Supercut tungsten carbide



**1 Black Bow (left ring)**  
Left-handed instrument

# Supercut Operating Scissors

## Dressing Scissors

Supercut, blunt/blunt



145mm long

Description
Straight
Curved

## Metzenbaum Dissecting Scissors

Supercut



Straight (length)

Description
147mm
185mm
200mm
230mm
250mm
280mm

Curved (length)

Description
147mm
185mm
200mm
230mm
250mm
280mm

## Dressing Scissors

Supercut, blunt/sharp



145mm long

Description
Straight
Curved

## Stevens Tenotomy Scissors

Supercut



## Dressing Scissors

Supercut, sharp/sharp



145mm long

Description
Straight
Curved

Curved/blunt

Description
114mm long
125mm long
135mm long

Curved/sharp

Description
114mm long
140mm long
160mm long

## Mayo Scissors

Supercut



Straight

Description
140mm long
160mm long
170mm long

Curved

Description
140mm long
160mm long
170mm long

Description

Straight/blunt, 114mm long
Straight/sharp, 114mm long
Straight/sharp, 180mm long

With cutout, 110mm long

Description
Straight/blunt
Curved/blunt

## Strabismus Scissors

Supercut



114mm long

Description
Straight
Curved

## Boyd Scissors

Supercut, blunt/blunt



Description
180mm long

## Iris Scissors

Supercut



114mm long

Description
Straight
Curved



# Needle Holders

## Bruce Clarke Needle Holder

Screw joint

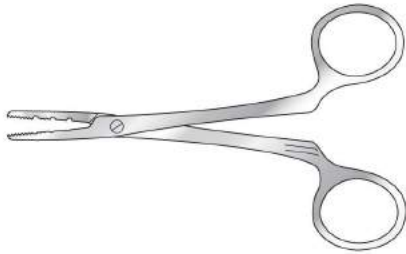

**Description**  
127mm long

## Lawrence Needle Holder

Fine jaw, 150mm long

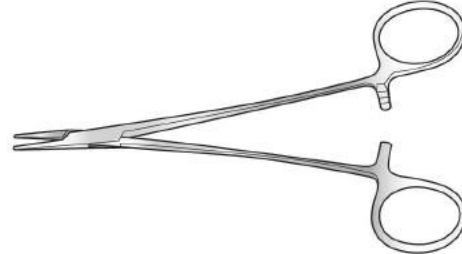

**Description**  
Tungsten carbide jaw

## Crile-Wood Needle Holder

Straight, baby, fine

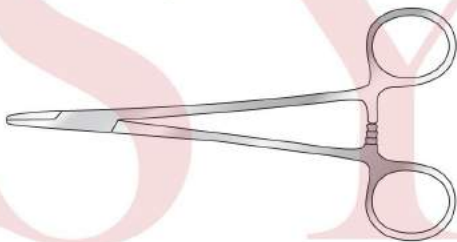

**Description**  
150mm long

## Needle Holder

Surgical Holdings pattern, box joint, lightweight, with curved plain jaws and one offset bow for thumb

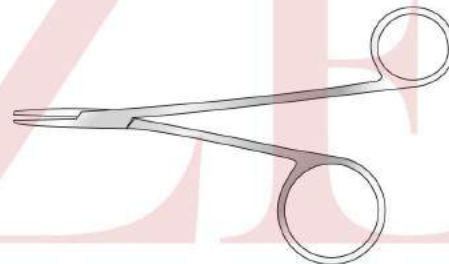

**Description**  
152mm long

## Kilner Needle Holder

Box joint, cross-serrated jaw

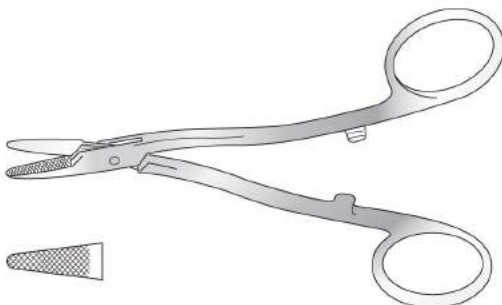

**Description**  
165mm long  
133mm long

## MacPhail Needle Holder

Screw joint, with one copper jaw

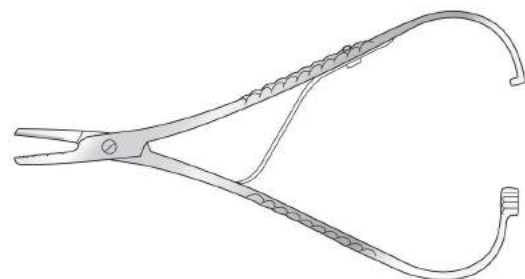

**Description**  
159mm long  
178mm long  
209mm long

SURGEON'S FIRST CHOICE

# Needle Holders

## Mathieu Needle Holder

Screw joint



Description
172mm long
209mm long
243mm long

## Naughton Morgan Needle Holder

Box joints, cross serrated jaws

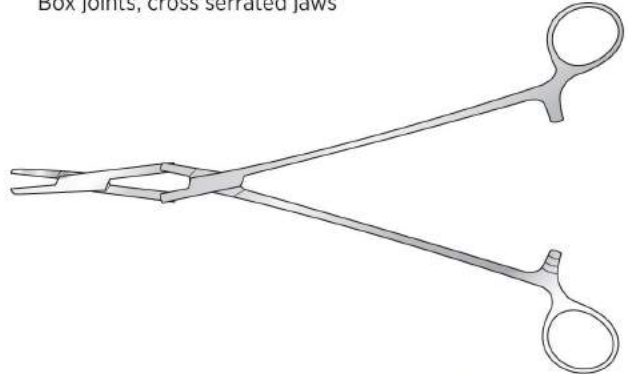

## Mayo Needle Holder

Box joint, straight

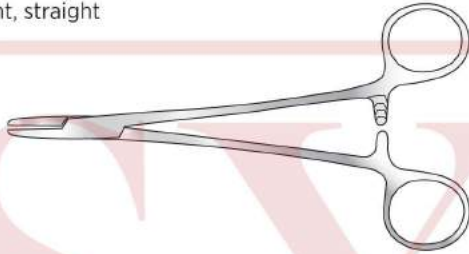

Wide cross serrated jaws

Description
159mm long
203mm long

Narrow cross serrated jaws

Description
159mm long

Tungsten carbide

Description
185mm long
254mm long

Description
185mm long
254mm long

## Rochester-Mayo Needle Holder

Screw joint

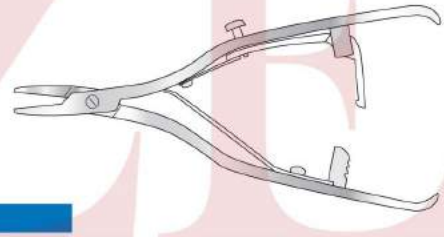

Description
178mm long

## Choosing the most suitable needle size

Our tungsten carbide inserts are available in a variety of styles. Choosing the most suitable needle size for each procedure helps give the surgeon maximum grip and control.

### Coarse 0.65mm

For powerful needle holder patterns and wire twisters. Maximum holding capabilities for heavy needles or wire.



### Standard 0.5mm

Used, for example, in Mayo-Hegar, Mathieu Needle Holders. For needles 3-0 and larger.



### Fine 0.4mm

For delicate needle holders such as Crile-Wood and DeBakey. For needles and sutures between 4-0 and 6-0.



### Micro 0.2-0.3mm

For micro needle holders such as Castroviejo, Microvascular and Mini-Ryder. For delicate needles and sutures between 7-0 and 10-0.



### Smooth

Smooth tungsten carbide surface reduces damage to delicate needles and suture of 6-0 and finer.



# Tungsten Carbide Needle Holders

## Berry Needle Holder/Wire Twister

Tungsten carbide jaws

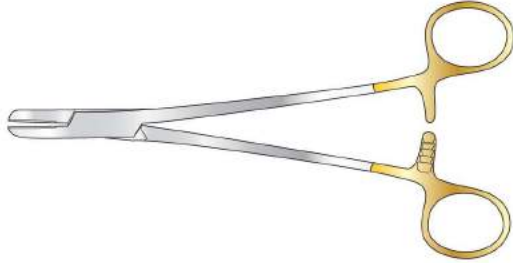

**Description**

200mm long

## Finochietto Needle Holder

Tungsten carbide jaws

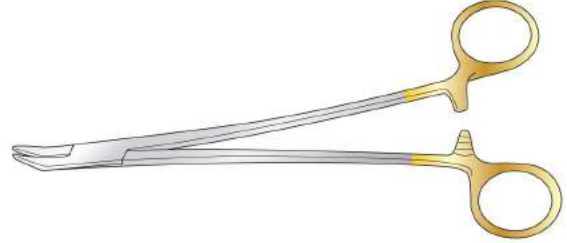

**Description**

215mm long  
265mm long

## Crile-Wood Needle Holder

Tungsten carbide insert, box joint, satin finish, straight

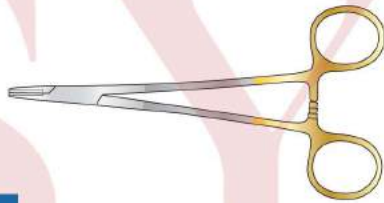

**Description**

159mm long  
178mm long  
150mm long

## Halsey Needle Holder

Tungsten carbide insert, box joint, satin finish, straight

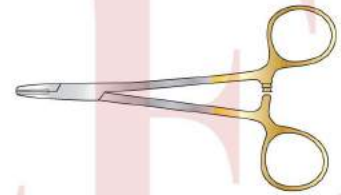

**Description**

127mm long

## Derf Needle Holder

Tungsten carbide insert



**Description**

115mm long

## Kilner Needle Holder

Tungsten carbide insert



**Description**

140mm long

# Tungsten Carbide Needle Holders

## Masing Needle Holder

Tungsten carbide insert, one angled bow

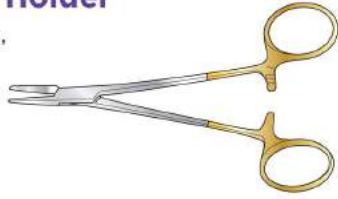

**Description**

130mm long

## Ryder Needle Holder

Tungsten carbide insert, box joint, satin finish, straight

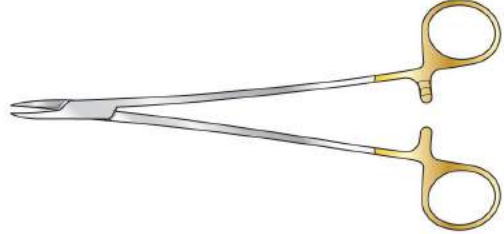

## Nievert Needle Holder

Tungsten carbide insert, box joint, satin finish, straight

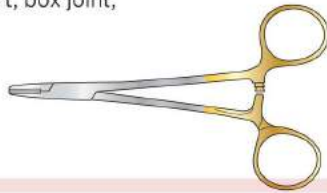

**Description**

127mm long

**0.2mm jaw ditch**

**Description**

135mm long  
155mm long  
175mm long  
210mm long

**0.4mm jaw pitch**

**Description**

135mm long  
155mm long  
175mm long  
210mm long

## DeBakey Needle Holder

250mm long

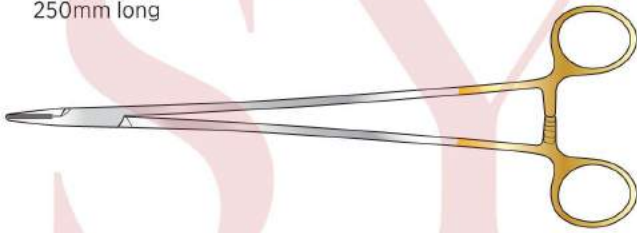

## Sarot Needle Holder

Diamond jaw, tungsten carbide, gold plated bows

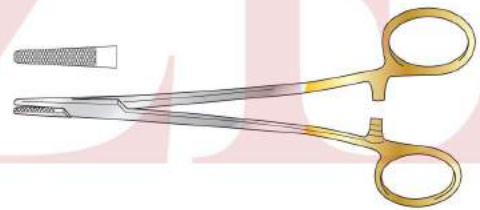

## Tungsten Carbide Needle Holders

### Features and Benefits

**Jaw**

Tungsten carbide inserts bonded into the jaws for a long lasting, secure grip

**Bevelled Edges**

Prevents suture from snagging

**Laser Etching**

Date and catalogue number are etched for easy re-ordering. Laser etch will not harm instrument like traditional methods

**Satin Finish**

Reduces glare

**Ratchets**

Precisely cut for effortless locking/unlocking

**Teeth**

Fine, hard teeth, diamond cut into an insert of hardened tungsten carbide for superior needle grasping and suture tying capabilities

**Vacuum Brazing**

Combines bonding of the tungsten carbide insert with the simultaneous vacuum hardening of the instrument for greater durability and longevity

**Shanks**

Precision balanced for comfort and control

**Gold Handles**

For easy identification

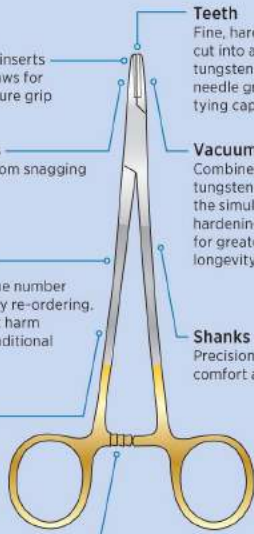

**Description**

181mm long

## Mayo-Hegar Needle Holder

Tungsten carbide insert, box joint, satin finish, straight

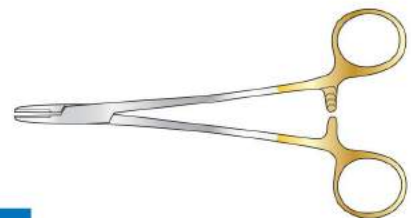

**Description**

130mm long  
159mm long  
178mm long  
209mm long

LONGER SIZES AVAILABLE

# Combined Scissor and Needle Holders

## Olsen-Hegar Scissor/Needle Holder

With tungsten carbide insert

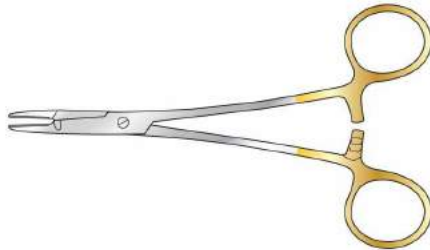

Description
147mm long
165mm long

## Olsen-Hegar Scissor/Needle Holder

Screw joint

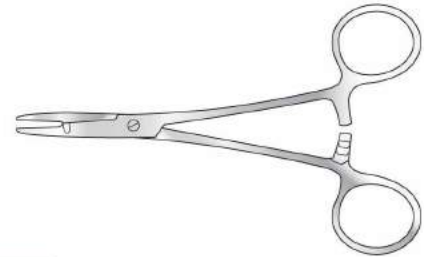

Description
140mm long
165mm long
190mm long

## Gillies Scissor/Needle Holder

Right-hand, with tungsten carbide insert

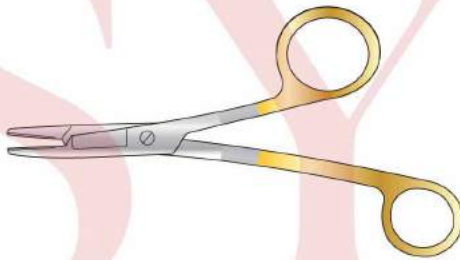

Description
158mm long

## Gillies Scissor/Needle Holder

Heavy pattern, 158mm long

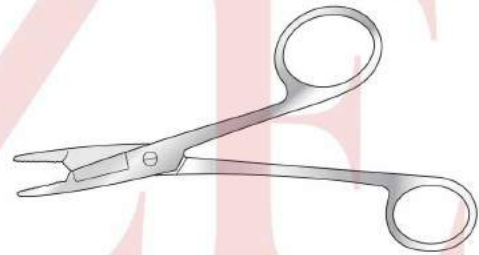

Description
Right-hand
Left-hand

## Gillies Scissor/Needle Holder

158mm long



Description
Right-hand
Left-hand

## Foster Gillies Scissor/Needle Holder

Fine pattern



Description
127mm long

SURGEON'S FIRST CHOICE

# Bag and Towel Clips

## Spring Clip

Serrated pattern, stainless steel, for fixing slings to leg splints, also for towel clipping

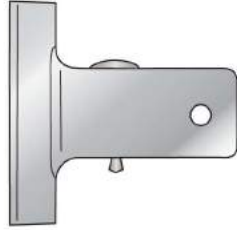

**Description**  
63mm wide

## Backhaus Towel Clip

Superior quality, box joint

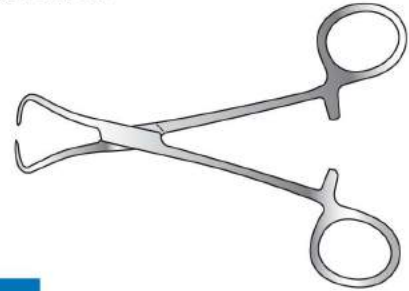

**Description**  
89mm long  
102mm long  
130mm long

## Spring Bag Clip

Serrated



**Description**  
26mm wide

## Moynihan Towel Clip

Screw joint, 2-2 teeth, for sides of incision

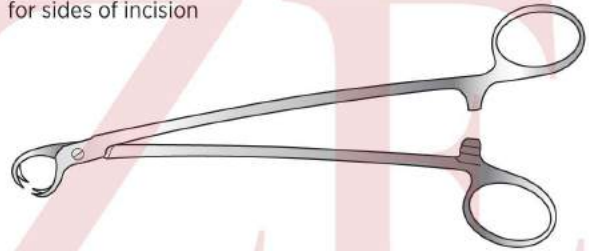

**Description**  
191mm long

## Jones Towel Clip

Superior quality spring forcep type



**Description**  
89mm long

## Ball and Socket Towel Forceps

Box joint



**Description**  
89mm long  
115mm long  
140mm long

## Shardles Towel Clip

Spring curved, cross action



**Description**  
77mm long

# Retractors

## Goligher Retractor

Complete with 2 centre blades:  
 1 x 90mm wide x 50mm deep  
 1 x 90mm wide x 90mm deep

and 2 pairs of lateral blades:  
 1 pair 25mm wide x 45mm deep  
 1 pair 50mm wide x 90mm deep



## Miles Retractor

Complete with 2 centre blades:  
 1 x 90mm wide x 50mm deep  
 1 x 90mm wide x 75mm deep

and 2 pairs of lateral blades:  
 1 pair 80mm wide x 35mm deep  
 1 pair 80mm wide x 75mm deep

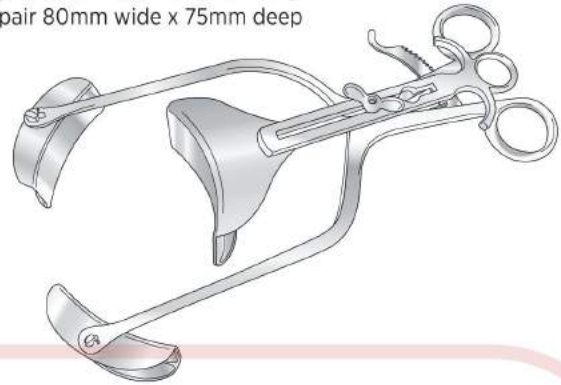

**Description**

340mm long

OTHER BLADE SIZES AVAILABLE

## Balfour Abdominal Retractor

Trivalve, frame 203mm

**Child**

102mm opening, 51mm deep lateral blades,  
 38mm deep centre blade

**Adult**

178mm opening, 64mm deep lateral blades,  
 44mm deep centre blade

**Extra large**

178mm opening, 102mm deep lateral blades,  
 108mm deep centre blade

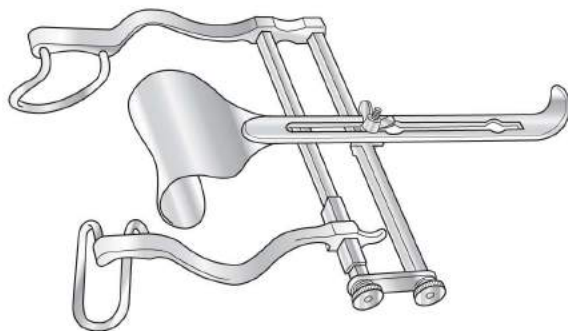

**Description**

Child

Adult

Extra large

## Balfour Abdominal Retractor

Bivalve, baby

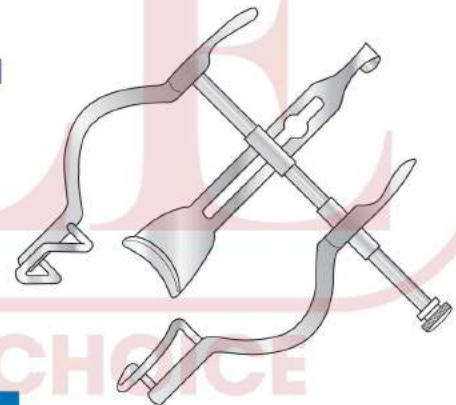

**Description**

Fully open 89mm

## Berkeley Abdominal Retractor

Parallel action

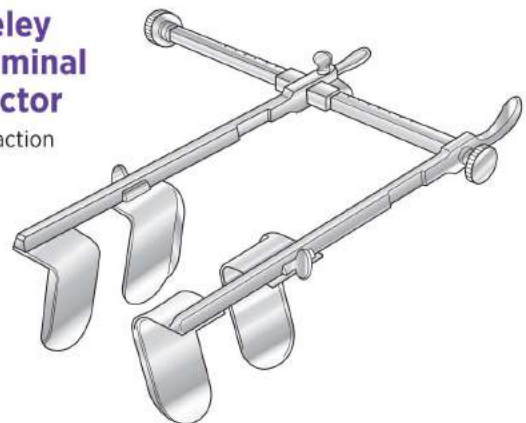

**Description**

Blades 35mm x 60mm deep, 215mm long

# Turner Warwick Retractors

## Turner Warwick Universal Self Retaining Retractor

Description
With frames A/B/C/D and blades A/B/C/D/E/F/K/L
Circular frame A only 178mm
Circular frame B only 229mm
Circular frame C only 305mm
Oval frame D only 475mm x 330mm
Oval frame E only 370mm x 300mm

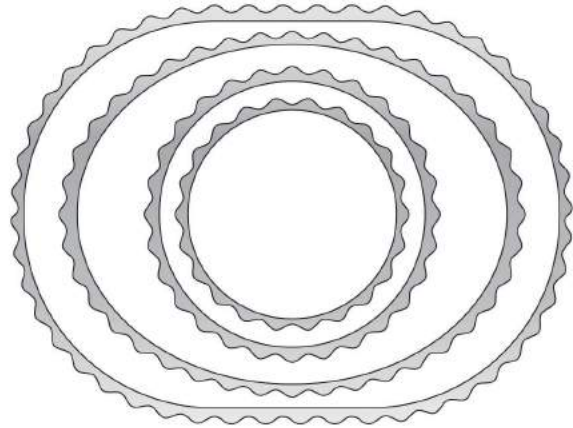

## Turner Warwick Needleholder with Tungsten Carbide Jaws

Curved shanks with one short bow

Description
230mm long
200mm long

### Blade A



Description
Blade only - 19mm x 76mm

### Blade B

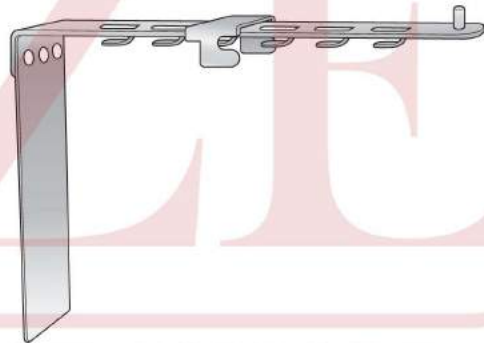

Description
Blade only - 38mm x 102mm

### Blade C

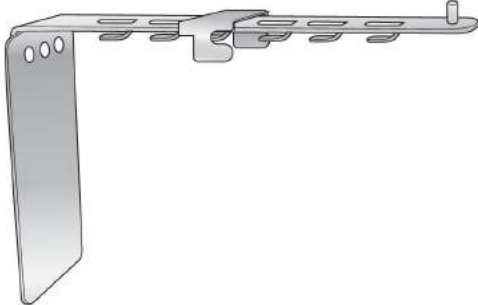

Description
Blade only - 57mm x 89mm

### Blade D

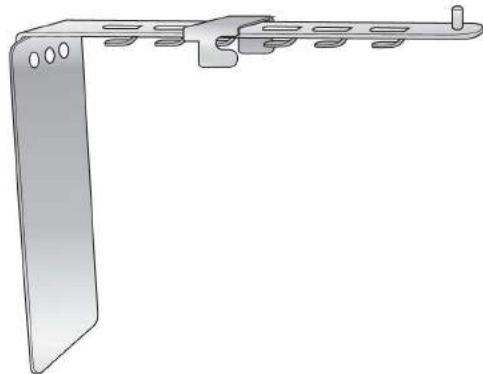

Description
Blade only - 57mm x 114mm



# Turner Warwick Retractors

## Blade E

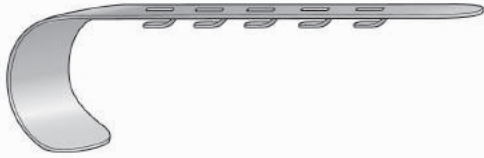

### Description

Blade only - curved stainless steel blade 51mm x 38mm

## Blade F

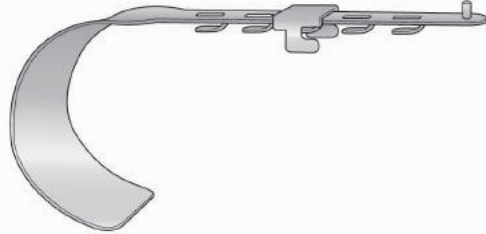

### Description

Blade only - curved stainless steel blade 76mm x 60mm

## Blade G

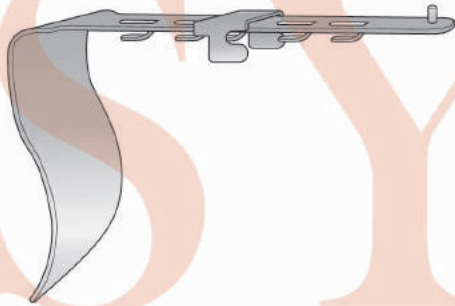

### Description

Blade only - flat stainless steel blade 89mm x 60mm

## Blade J



### Description

Blade only - single hook, 15mm deep

## Blade K

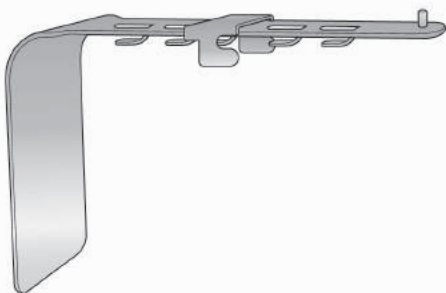

### Description

Blade only - flat with clip 55mm x 90mm

## Blade L

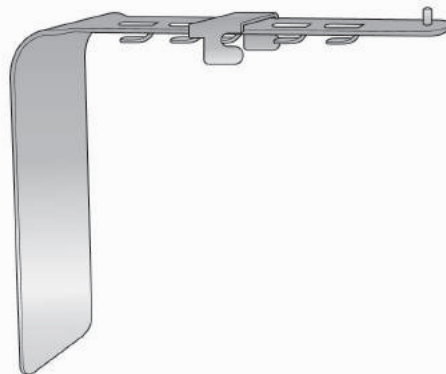

### Description

Blade only - flat with clip 55mm x 120mm

# Retractors

## Collin Retractor

110mm fully open, 235mm long

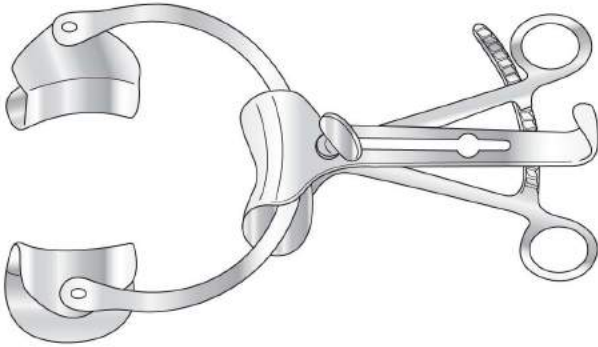

**Description**

Complete with centre blade 55 x 40mm and one pair of blades 38mm x 60mm  
Without centre blade

## Joll Thyroid Retractor

Self retaining, with lock-in nut

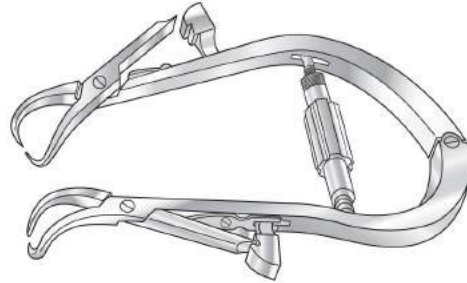

**Description**

152mm long

## Gelpi Retractor

Self retaining

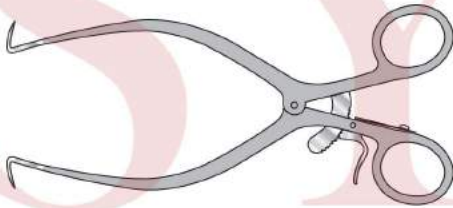

**Description**

140mm long  
178mm long

## Gossett Abdominal Retractor

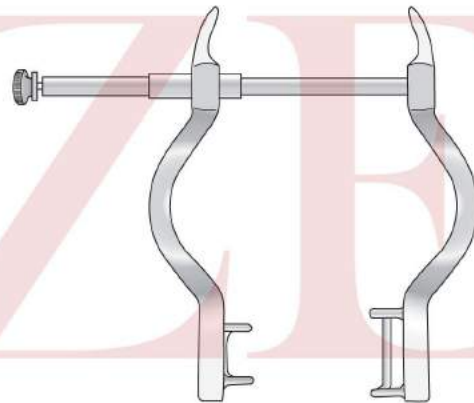

**Description**

Large, fully open 185mm long  
Small, fully open 95mm long

## Pozzi Abdominal Retractors

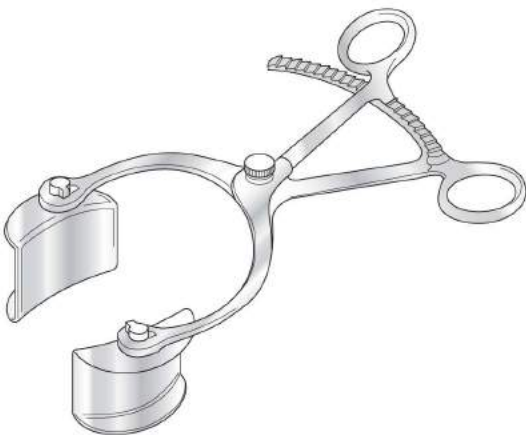

**Description**

Swivel blades: 38 x 60mm, bivalve, 254mm long

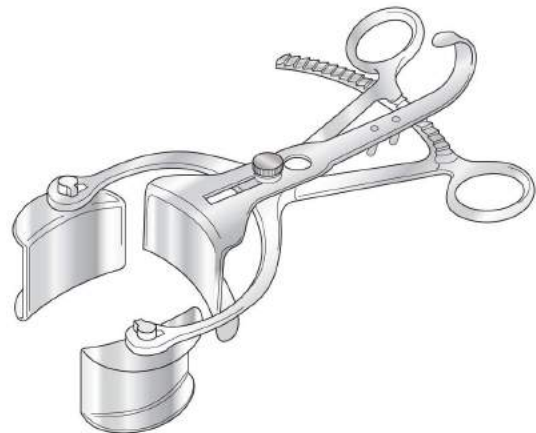

**Description**

Swivel blades: 38 x 59mm, trivalve, 203mm long

# Retractors

## Bowlby Dilator

Curved

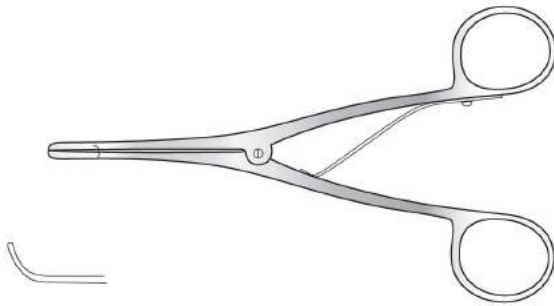

**Description**

145mm long

## Travers Retractor

Self retaining with internal rack, 210mm long

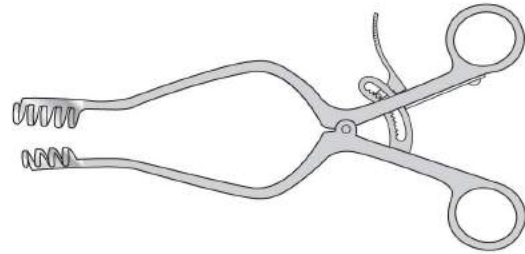

**Description**

4 x 5 teeth, 95mm fully open

## Irwin Retractor

Self retaining, with cam rack, 4 x 4 teeth

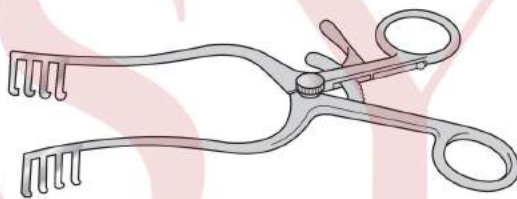

**Description**

178mm long

## West Retractor

Self retaining, 140mm long

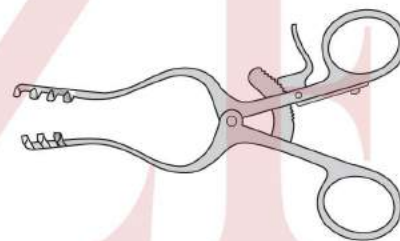

**Description**

3 x 4 teeth, 60mm fully open

3 x 4 teeth, 60mm fully open, with cam rack

SURGEON'S FIRST CHOICE

## Norfolk and Norwich Retractor

4 x 5 teeth 50mm blades x 223mm long

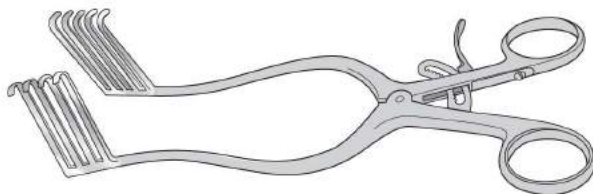

**Description**

Standard rack

## Weitlander Retractor

3-4 teeth

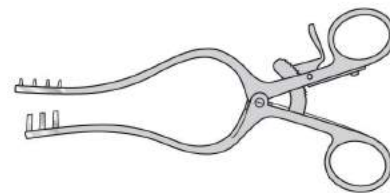

135mm long

**Description**

Blunt

Sharp

Sharp, 2-3 teeth

Blunt, 2-3 teeth

165mm long

**Description**

Blunt

Sharp

# Retractors

## Kocher Retractor



230mm long

Description
36 x 20mm blade

250mm long

Description
67 x 25mm blade
80 x 42mm blade
80 x 50mm blade
80 x 60mm blade

## Canny Ryall Navy Retractor

Double-ended, with one single hook blade 5mm wide, and one fenestrated blade

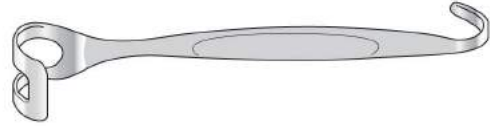

Description
Fenestrated blade 16mm wide, 190mm long
Fenestrated blade 19mm wide, 190mm long
Fenestrated blade 25mm wide, 220mm long
Fenestrated blade 30mm wide, 220mm long

## Kocher Langenbeck Retractor

215mm long



Description
25 x 6mm blade
35 x 8mm blade
35 x 11mm blade
35 x 15mm blade
41 x 11mm blade

Description
55 x 11mm blade
70 x 15mm blade
80 x 12mm blade
80 x 16mm blade

## Canny Ryall Army Retractor

Double prong, 13mm wide, 165mm long

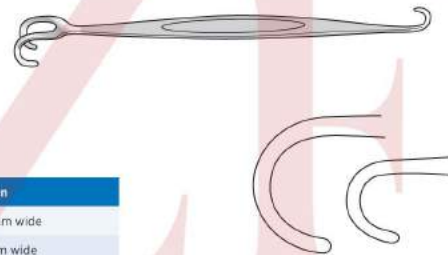

Description
Large, 19mm wide
Small, 11mm wide

## Langenbeck Retractor

Single ended



Description
Blade 22mm x 6mm
Blade 45mm x 13mm
Blade 65mm x 13mm
Blade 75mm x 25mm
Blade 65mm x 25mm

## Czerny Retractor

Double ended



Description
171mm long

## Landon Retractor



Description
230mm



## Lane Retractor

Double ended blade, 229mm long

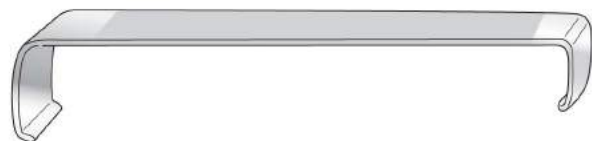

Description
13mm x 19mm wide
25mm x 32mm wide

# Retractors

## Morris Retractor

Single blade, 229mm long

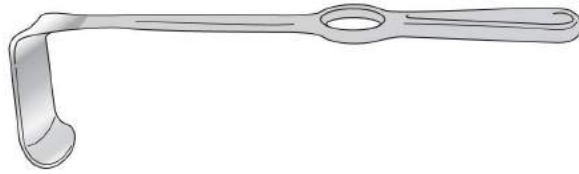

Description
38 x 51mm
51 x 51mm
64 x 51mm

## Morris Retractor

Double ended, 216mm long

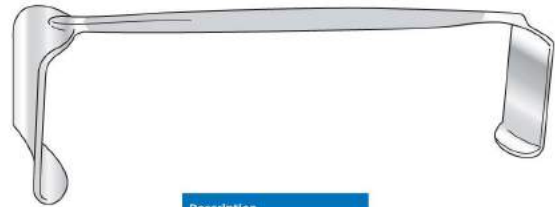

Description
32 x 51mm and 38 x 51mm
44 x 51mm and 51 x 51mm
64 x 51mm and 38 x 51mm

## Moynihan Retractor

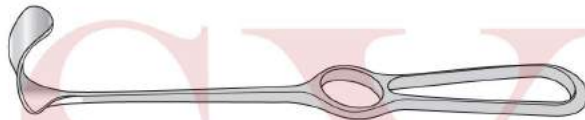

Description
Single ended, blade 13 x 22mm, 215mm long

## Deaver Abdominal Retractors



Description
Set of 5, 315mm overall length
25mm wide
25mm wide
38mm wide
51mm wide
76mm wide

## Elliot (Modified Deaver) Retractor



Description
With flat handle

## Dyball and Lock Retractor

For liver



Description
64 x 144mm, 241mm long

OTHER SIZES AVAILABLE - PRICE ON APPLICATION

## Deaver Abdominal Retractors

With round handles



Description
Set of 5, 305mm overall length
25mm wide
25mm wide
38mm wide
51mm wide
76mm wide

## Kelly Retractor Blade

267mm long



Description
38 x 191mm
57 x 191mm

# Retractors

## Durham Retractor

With fenestrated blade, 216mm long



Description
10mm wide
14mm wide
20mm wide

## Kocher Retractor



Description
Sharp, 205mm long
Sharp, 220mm long
Blunt, 220mm long

## Ballance (Volkman) Retractor

203mm long



### Sharp

Description
1 prong
2 prong
3 prong
4 prong
6 prong

### Blunt

Description
1 prong
2 prong
3 prong
4 prong
6 prong

## Senn-Miller Retractor

170mm long



## Single Hook Retractor

Sharp



Description
152mm long
Half size, fine

## Volkman Retractor



Description
Sharp, 220mm long
Blunt, 220mm long
Shero, 245mm long

## Gillies Skin Hook

Solid handle, 190mm long



Description
Standard, fine
Half size, fine

## Kilner Retractor

Double ended, cat's paw



Description
152mm long

# Dissectors and Probes

## MacDonald Dissector Double Ended



**Description**  
191mm long

## Probe, Sinus Silver



**Description**  
152mm long

## Brodie Director Probe Ended, Silver Plated



**Description**  
165mm long

## Probe, Fish Tail Silver Plated



**Description**  
127mm long  
152mm long  
203mm long  
254mm long

## Watson Cheyne Dissector

Fine, double-ended, with probe end



**Description**  
127mm long  
191mm long  
230mm long  
255mm long

## Jobson Horne Probe Dressing (Aural)

With one flat tapered end, serrated edge and one small ring end, stainless steel



**Description**  
140mm long  
178mm long

## Probe, Malleable Silver Plated



**Description**  
127mm long  
152mm long  
178mm long  
203mm long  
255mm long  
305mm long

# Miscellaneous

## Aneurysm Needle

Small, for infusions



**Description**  
146mm long

## Mayo Instrument Pin

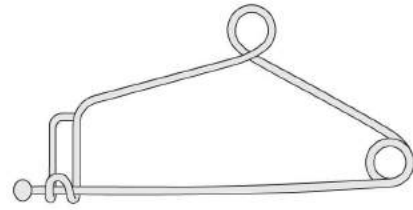

**Description**  
102mm long  
152mm long

## Syme Aneurysm Needle



**Description**  
165mm long

## Baron Scalpel Handle

130mm long



**Description**  
No 3  
No 4

## Ring Cutter

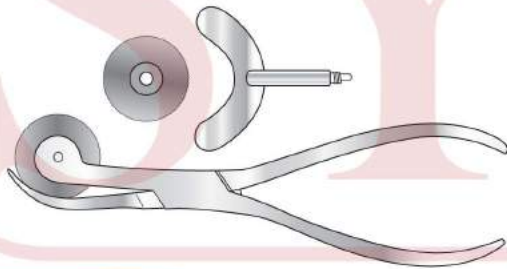

**Description**  
Circular saw blade, 165mm long  
Spare blade

## Scalpel Handle

127mm long



**Description**  
No 3  
No 4  
No 4 L  
No 7



# Hollow Ware

## Kidney Dish

Stainless steel

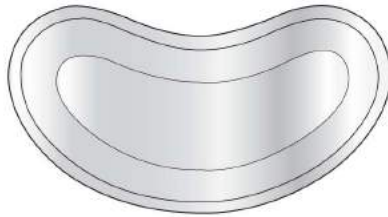

**Description**

- 152mm
- 203mm
- 254mm
- 305mm

## Cheate Jar

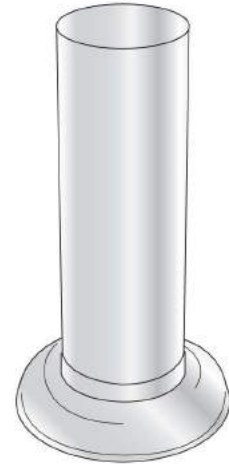

**Description**

Stainless steel, 203mm x 50mm

## Lotion Bowl

Without lid, stainless steel

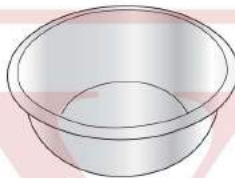

**Description**

- 102mm
- 152mm
- 203mm
- 254mm
- 305mm

## Measuring Jug



**Description**

1 litre capacity

## Instrument Tray

Stainless steel

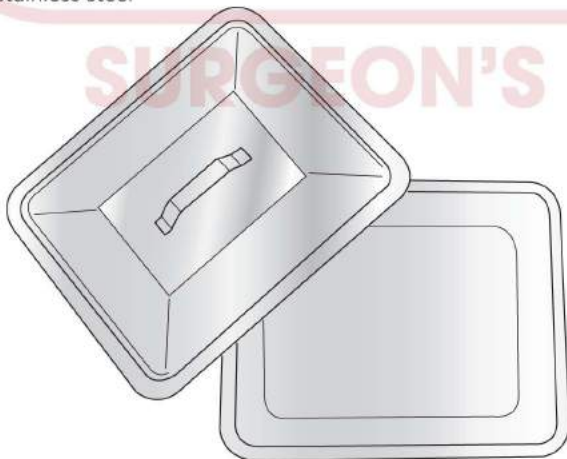

**Description**

- 254 x 203 x 50mm
- Lid only for 254 x 203 x 50mm
- 305 x 254 x 50mm
- Lid only for 305 x 254 x 50mm
- 356 x 305 x 50mm
- Lid only for 356 x 305 x 50mm

## Petri Dish



**Description**

100mm, stainless steel, with lid

## Gallipot



**Description**

Stainless steel, 63mm

# Silicone Matting and Wire Sterilising Baskets

## Silicone Matting

Medical grade for storage, sterilisation and transportation of instruments.

Cushion, protect, and organise delicate surgical instruments during storage, transportation, and sterilisation. Perforations allow for ventilation during the sterilisation process. The silicone mat can be cut to fit any size container.

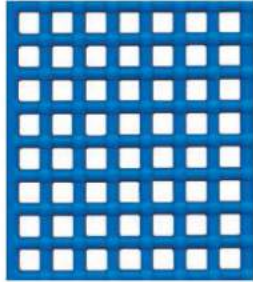

502mm long x 242mm wide  
7mm holes, 10mm between holes

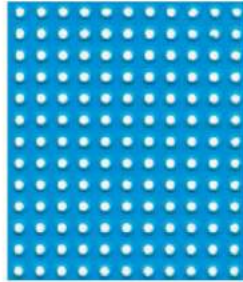

515mm long x 240mm wide  
3mm holes, 6mm between holes

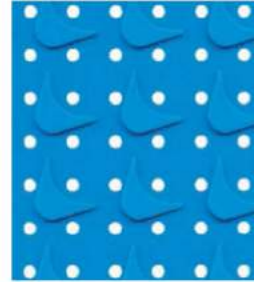

570mm long x 550mm wide  
4mm holes, 13mm between holes

## Sterilising Baskets

### DIN Basket

Wire mesh base with perforated sides and two carrying handles

Description
230 x 130 x 60mm
240 x 130 x 50mm
240 x 130 x 60mm
240 x 250 x 50mm
240 x 250 x 60mm
300 x 300 x 50mm
350 x 350 x 60mm
480 x 250 x 50mm
480 x 250 x 60mm

Description
480 x 250 x 70mm
480 x 400 x 60mm
480 x 480 x 50mm
480 x 480 x 60mm
500 x 300 x 50mm
550 x 430 x 50mm
600 x 300 x 60mm



### DIN Basket

Wire mesh basket with two carrying handles

Description
240 x 250 x 50mm
240 x 250 x 60mm
240 x 250 x 70mm
300 x 300 x 60mm
480 x 250 x 50mm

Description
480 x 250 x 60mm
480 x 250 x 70mm
480 x 250 x 100mm
480 x 480 x 50mm
480 x 480 x 70mm

### DIN Basket Lids

For perforated and wire mesh baskets

Description
240 x 250mm
300 x 300mm
480 x 250mm
480 x 480mm

### Did you know...

**Organising and fixing instruments in place can aid the cleaning process.**

Help keep your instruments in good condition for longer with our baskets and trays. Available in custom sizes, to suit your requirements perfectly.

[info@syze.co](mailto:info@syze.co)

# Wire Sterilising Baskets

## ENT Basket

Wire mesh base with perforated sides and two carrying handles, supplied with lid



**Description**  
480 x 250 x 160mm  
Fixing clamps

## Arthroscope Basket

Wire mesh base with two fixing clamps



**Description**  
290 x 80 x 52mm

## Endoscope Basket

With small lens basket

**Description**  
6400 x 150 x 77mm

Wire mesh base with two fixing clamps

**Description**  
S - 460 x 80 x 52mm  
D - 480 x 80 x 52mm  
D - 680 x 80 x 52mm

## Sieve



**Description**  
203mm x 50mm ø

## Fine Mesh Basket



With hinged take off / lockable lid

**Description**  
120 x 155 x 40mm  
120 x 155 x 50mm  
235 x 155 x 40mm  
235 x 155 x 50mm  
375 x 260 x 40mm

With separate lid

**Description**  
120 x 155 x 40mm  
235 x 155 x 40mm  
375 x 260 x 40mm

# Optical Fibre Cables

Our optical fibre cables are compatible with all major scopes and illuminators. Every light lead is high temperature xenon compatible, rated to the highest level of thermal resistance and tested to ensure the highest light output possible.

## Step 1: Proximal/Illuminator Connector

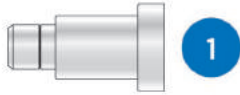

ACMI / Circon



Wolf / Dyonics



Wolf / Long

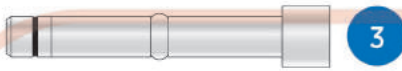

Olympus / ACMI



Storz



Pilling



Universal\*

**SURGEON'S FIRST CHOICE**

## Step 2: Distal/Instrument Connector

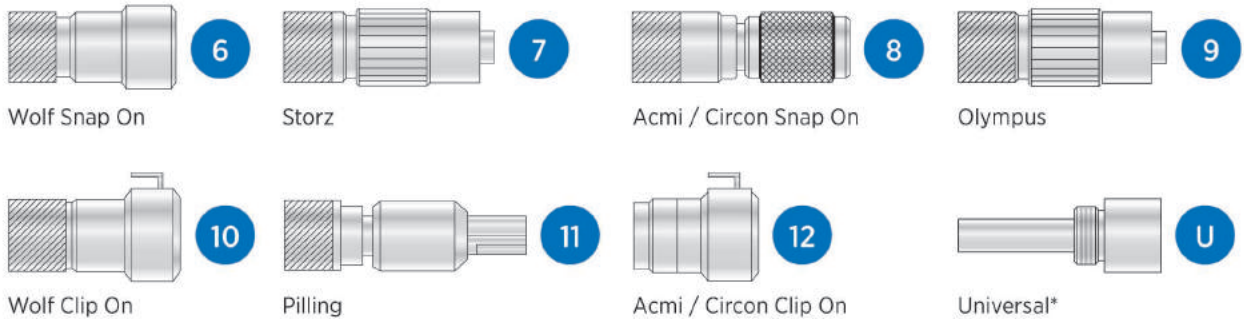

\*A screw-on adapter is necessary for this connector and must be ordered separately

## Step 3: Fibre Optic Bundle Size

Place gauge on bundle to determine diameter

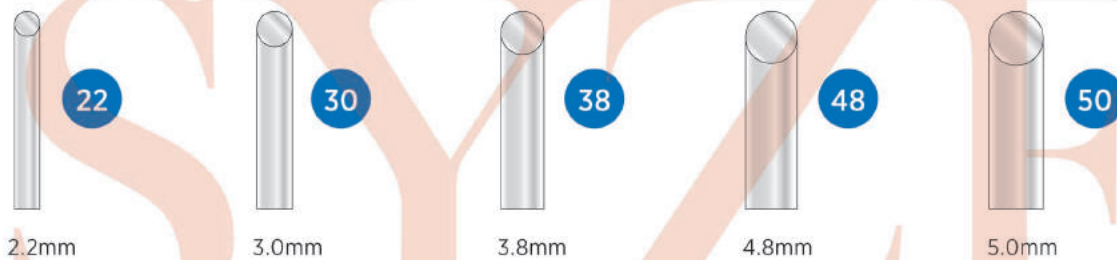

## Step 4: Fibre Optic Cable Length

Custom lengths available



## Step 6: Sheathing Type

- 0 Non-reinforced
- 6 152mm Reinforced Ends
- FR Fully Reinforced

## Step 7: Sheathing Colour

