

Intestinal

Forceps	110
Clamps	112
Miscellaneous	113

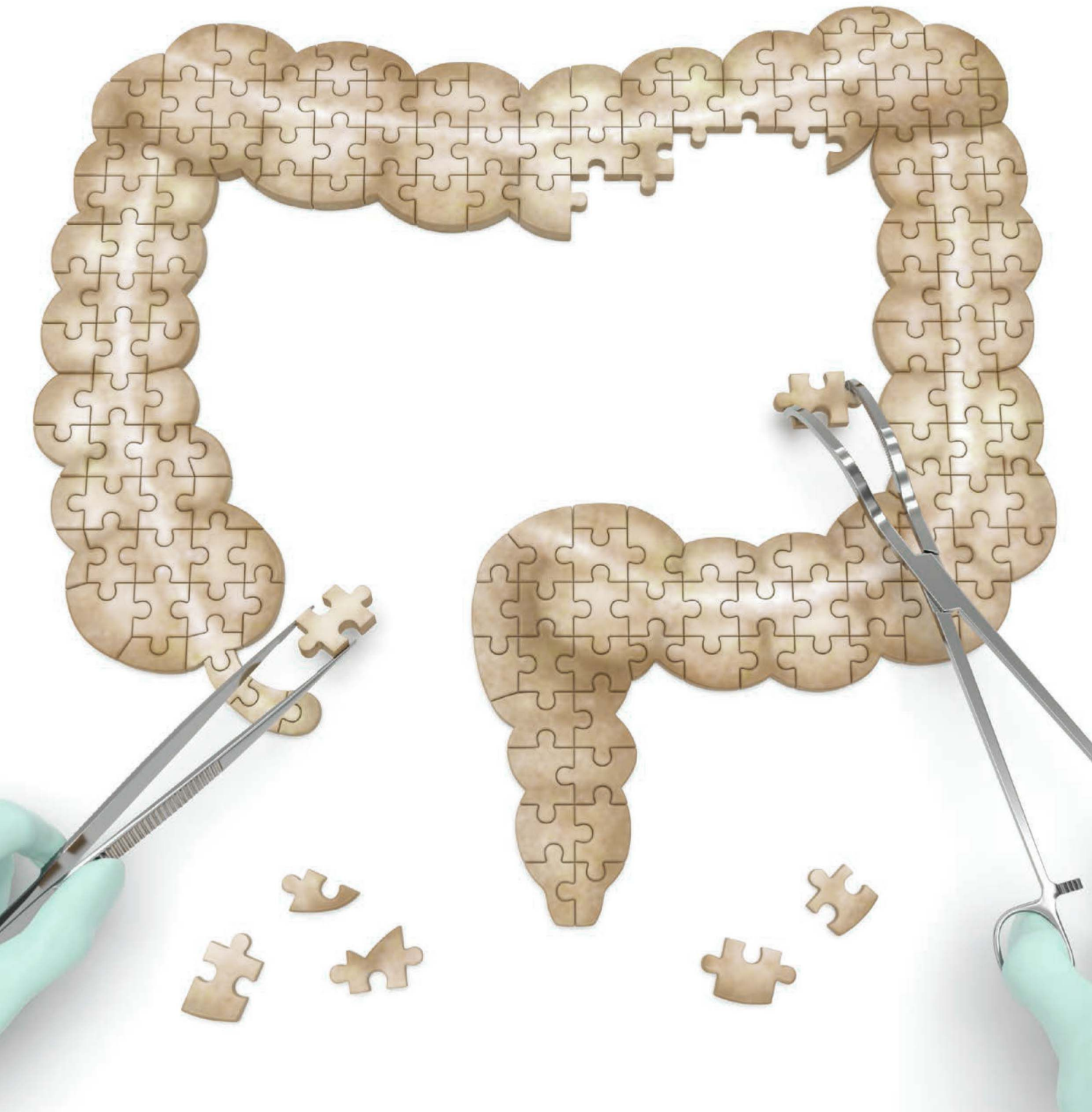

Forceps

Desjardin Gall Stone Forceps

Screw joint

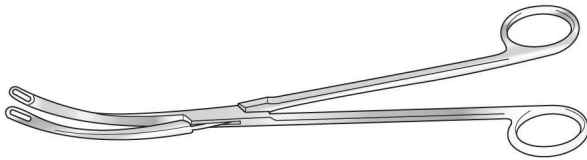

Description

Small, 220mm long

Large, 238mm long

Lane Stomach Holding Forceps

Straight, serrated jaws, screw joint

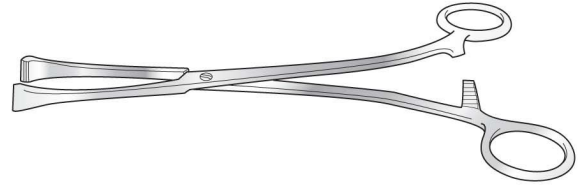

Description

203mm long

Babcock Intestinal Forceps

Straight, extra light

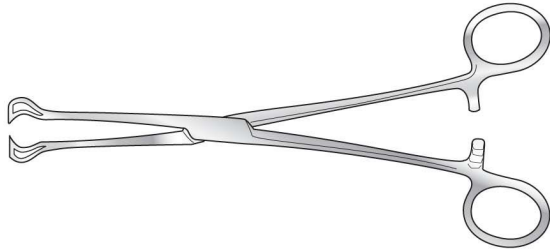

Description

203mm long

Lahey Cholecystectomy Forceps

Curved, longitudinal serrations, heavier pattern

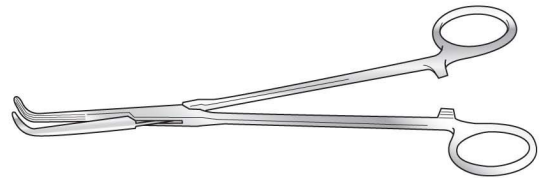

Description

76mm blades, 197mm long

225mm long

Maingot Intestinal Forceps

Straight, serrated tip, fenestrated grip

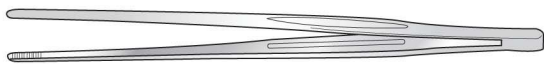

Description

203mm long

Lahey Sweet Forceps

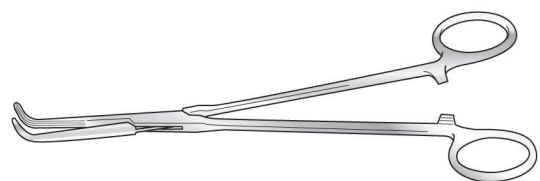

Description

200mm long

225mm long

230mm long

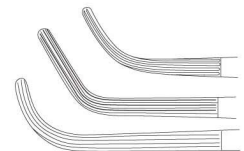

Denis Browne Intestinal Forceps

Straight, serrated tips, fenestrated jaws



Description

178mm long

Moynihan Cholecystectomy Forceps

Curved on flat, screw joint

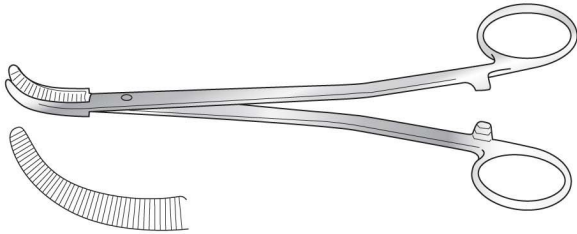

Description

215mm long

Kocher Intestinal Forceps

With light spring blades and longitudinal serrations

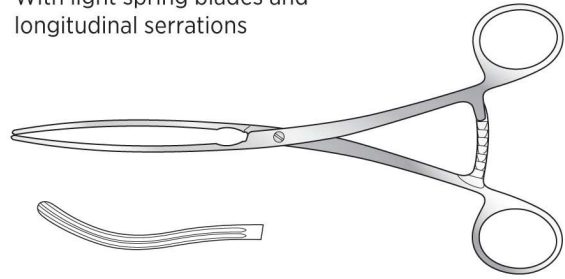

Description

Straight, 90mm blades, 210mm long

Curved, 85mm blades, 210mm long

Lane Intestinal Forceps

110mm blades, longitudinal serrations
240mm long

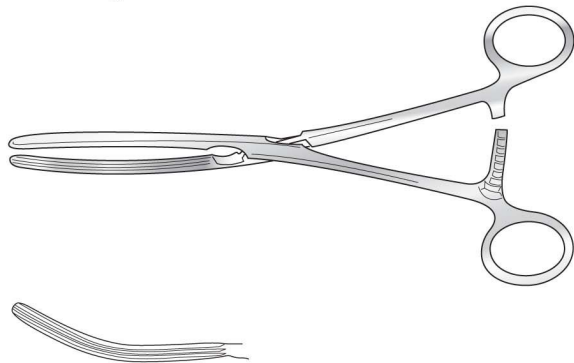

Description

Straight

Curved

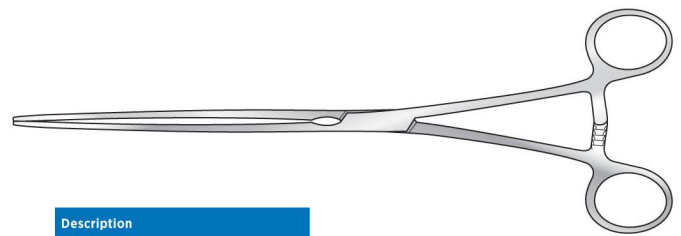

Description

Straight, 120mm blades, 250mm long

Curved, 115mm blades, 250mm long

Straight, 150mm blades, 250mm long

Curved, 145mm blades, 250mm long

Seton Pringle Intestinal Forceps

Straight, longitudinal serrations
178mm long

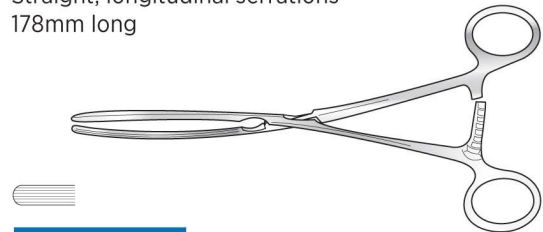

Description

Fine blades 2.5mm wide

Forceps and Clamps

Lang Stevenson Intestinal Forceps

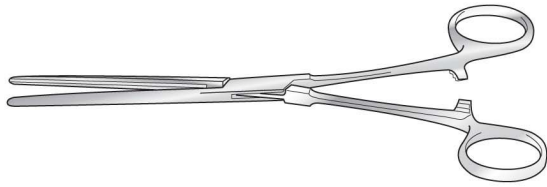

Description

82mm jaw, keyed blades, 203mm long



Schoemaker-Ogilvie Colectomy Forceps

Straight, hollow blades

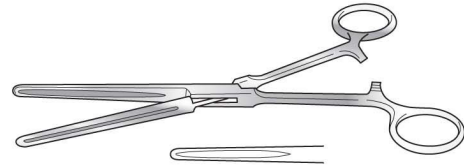

Description

171mm long

203mm long

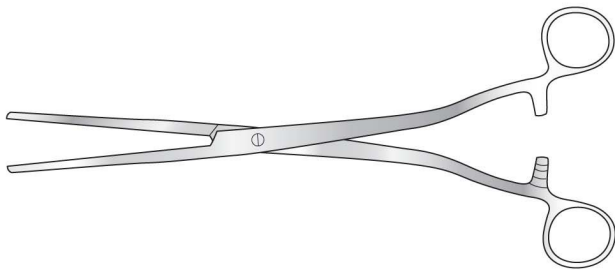

Parker Kerr Intestinal Forceps/Clamp

Blades 89mm, 254mm long

Description

Curved

Straight



Hartman Intestinal Clamp

With diagonal serrations, 200mm long

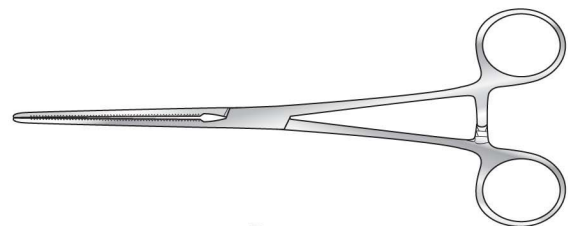

Description

Straight

Curved

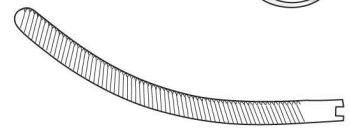

Guard/Shoe

SC-IN/017b curved, fenestrated inner or outer curve, 89mm

Description

Straight, 89mm

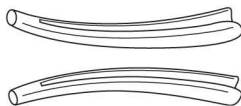

Payr Intestinal Clamp

Crushing, lever action, longitudinal serrations

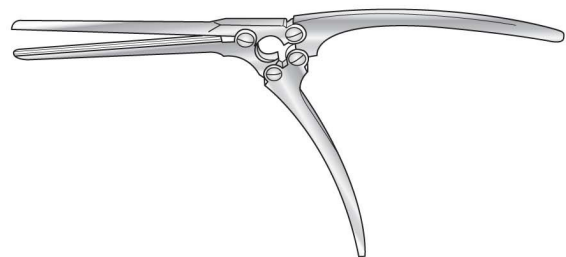

Description

Extra small, 50mm blades, 150mm long

Small, 65mm blades, 210mm long

Medium, 100mm blades, 240mm long

Large, 150mm blades graduated in inches, 360mm long

Doyen Intestinal Clamp

240mm long

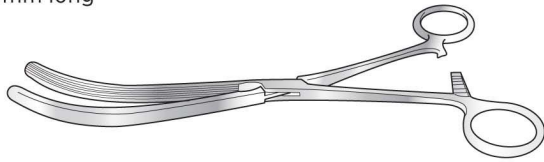

Description
Straight
Curved

Zachary Cope Anastomosis Clamp

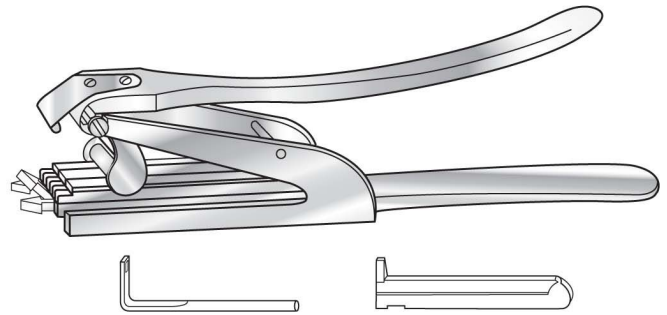

Description
Set: 3 clamps, lever action closing device and tommy bar, 233mm long
Set of 3 clamps
Tommy bar for set, 103mm long

Lane Twin Stomach Clamp

Longitudinal serrations
large, 150mm blades, 305mm long

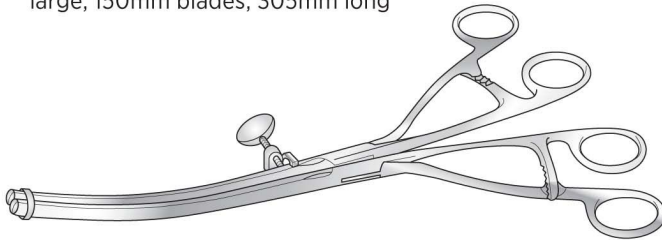

Description
Straight
Curved

Bakes Bile Duct Dilators

Malleable stems, 203mm long



Description
Set of nine
3mm ø head
4mm ø head
5mm ø head
6mm ø head

Description
7mm ø head
8mm ø head
9mm ø head
10mm ø head
11mm ø head

Taking care of your instruments

It is really important to ensure your instruments remain safe.

To do this, you will need a device which allows you to magnify distal areas of the instruments to check for:

- Burrs
- Corrosion
- Cracks



Contact us for more advice on taking care of your instruments info@syze.co

Yankauer Suction Tube

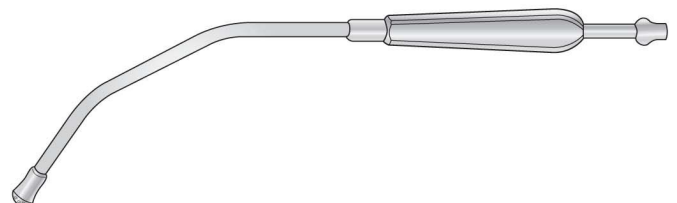

Description
305mm long